

S series smart lights

S Series smart lights

- Anti-glare smart spotlight
- Smart magnetic track light
- S Series light strip kit

FULL HOUSE SMART LIGHTING



Covering three major lighting categories

S Series smart light

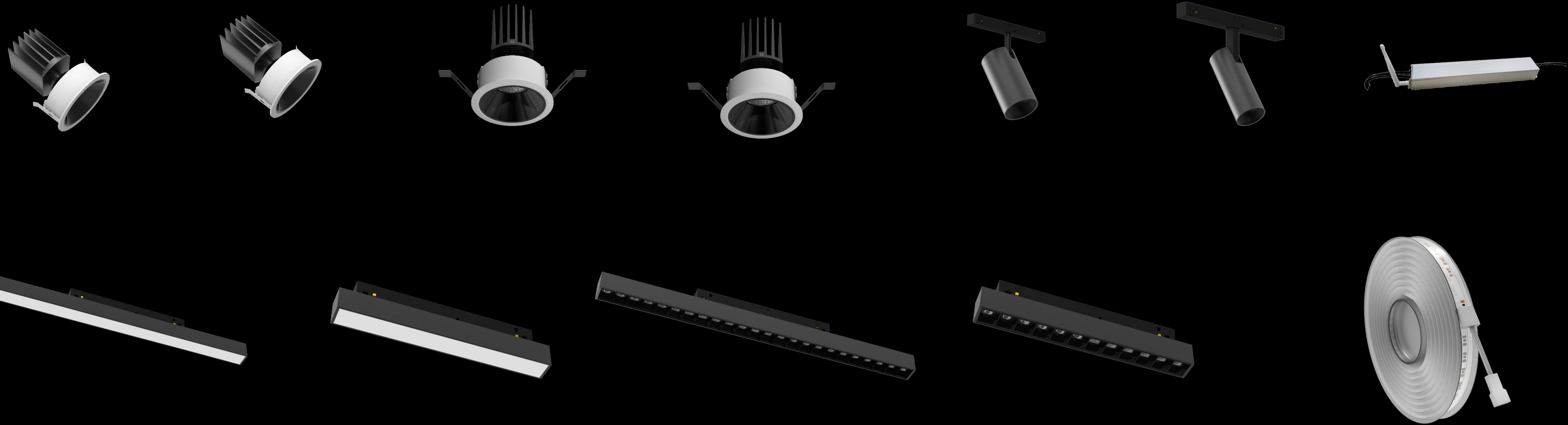

Smart magnetic track light

Smart light strip

Anti-glare smart spotlight

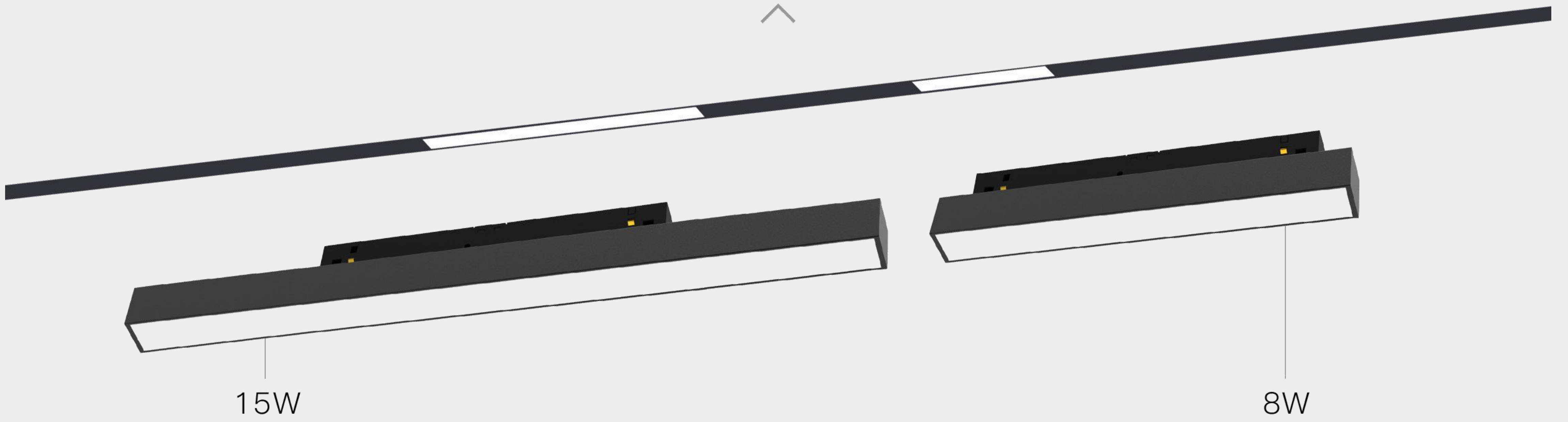

Smart magnetic track floodlight



Smart magnetic track grille light



15W

8W

Smart magnetic track spotlight

Aviation aluminum material

- High temperature resistance
- Corrosion resistance
- High pressure resistance
- Acid and alkali resistance



Six lighting functions

Task lighting

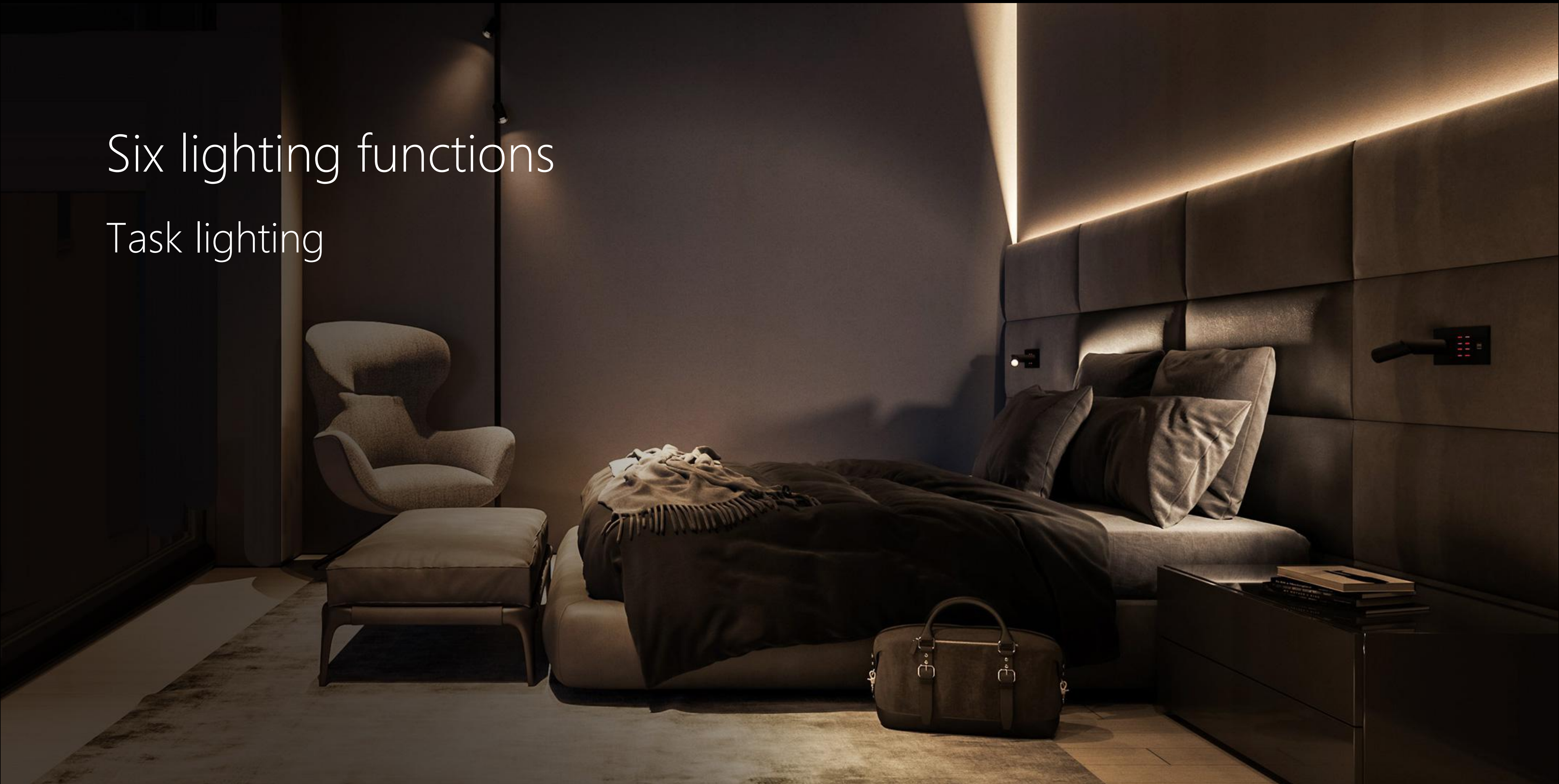

Six lighting functions

Atmosphere lighting

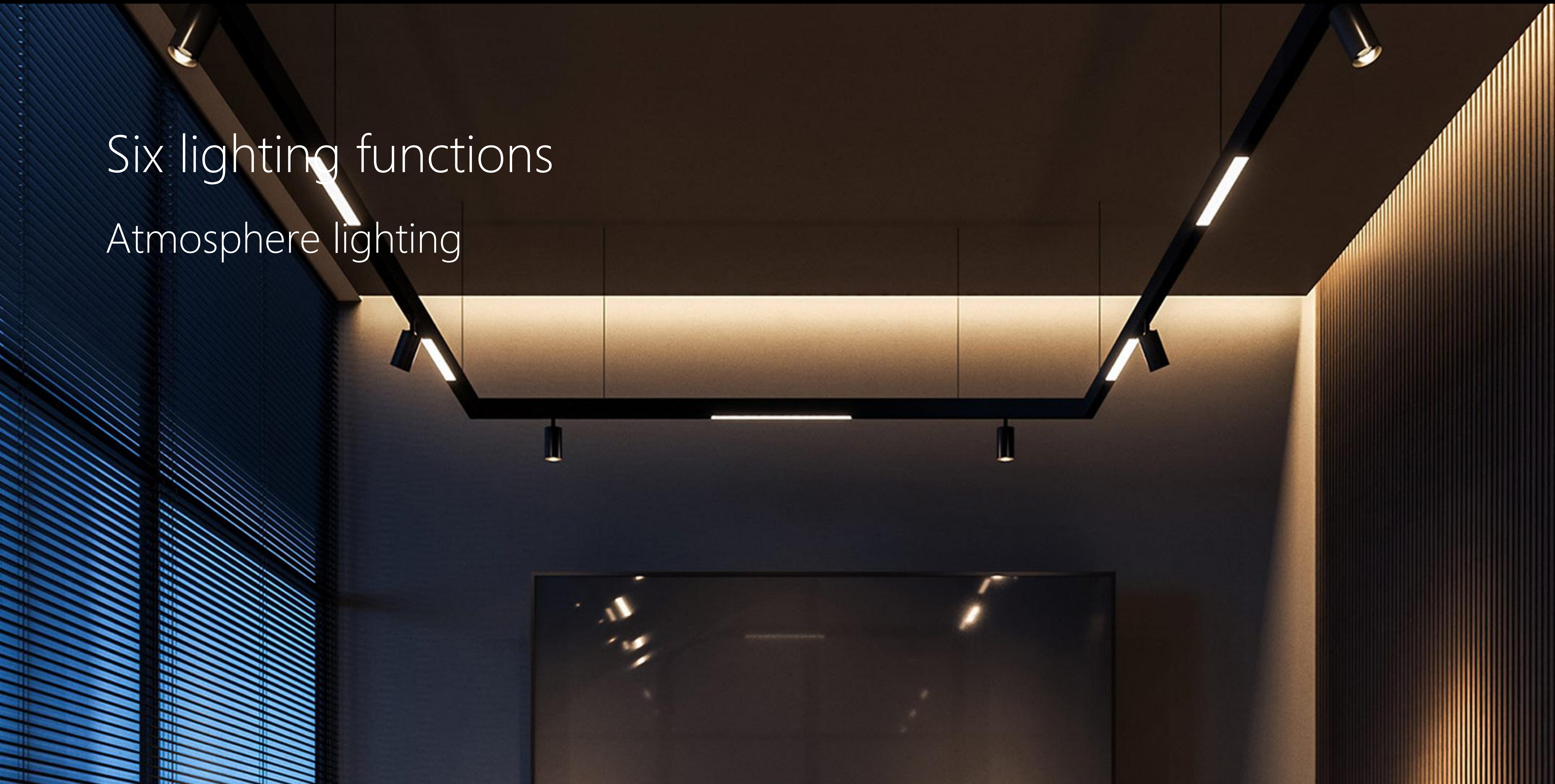

Six lighting functions

Decoration lighting



Six lighting functions

Display lighting



Six lighting functions

Accent lighting



Six lighting functions

Basic lighting



10000

level Dimming

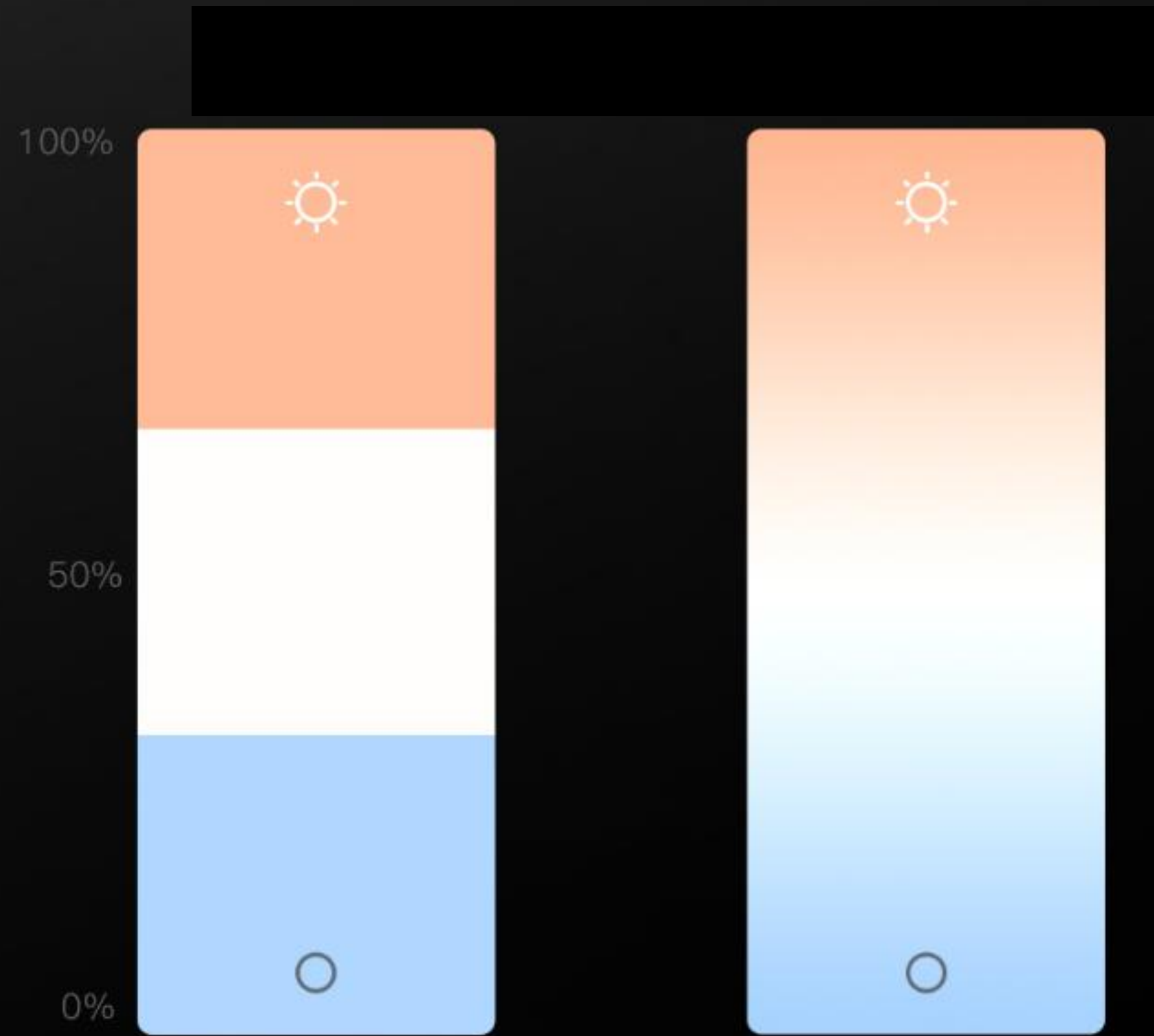

Normal Dimming

S series Dimming



S Series light strip
10000 level dimming



Anti-glare smart spotlight
4000 level dimming



Smart magnetic track light
4000 level dimming

98

Ra*High CRI

测试报告。



Intelligent lamp body structure design

Fast access to the network, fast lighting change

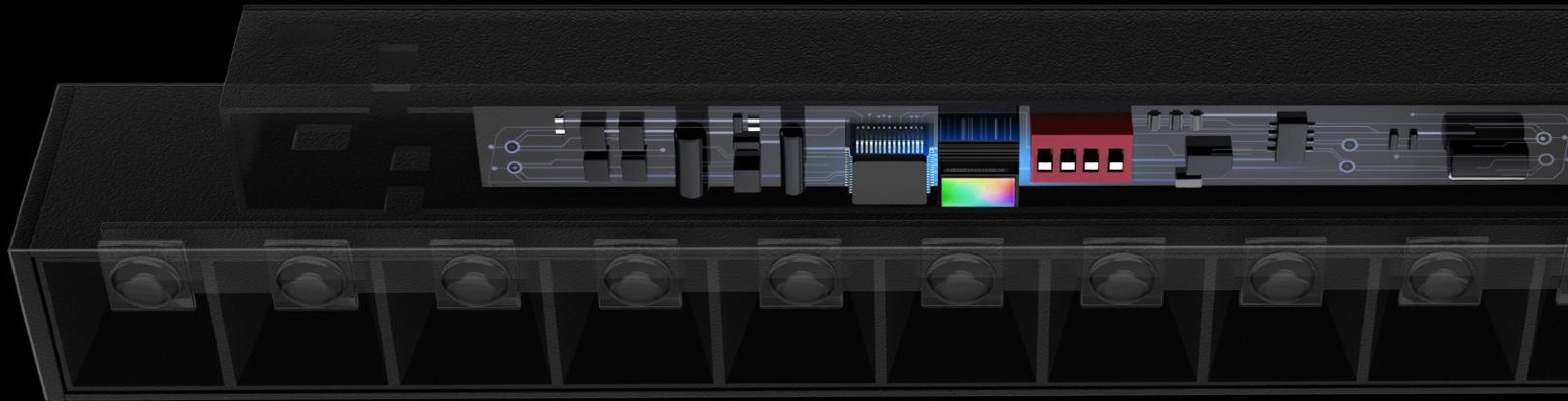

3-ways remote controls



MixPad
touch screen



MixPad
button control



ORVIBO Home
APP control

Ultra wide range Color Temperature



2700K-6500K
S Series light strip



2700K-6000K
Smart magnetic track light



2700K-6000K
Anti-glare smart spotlight

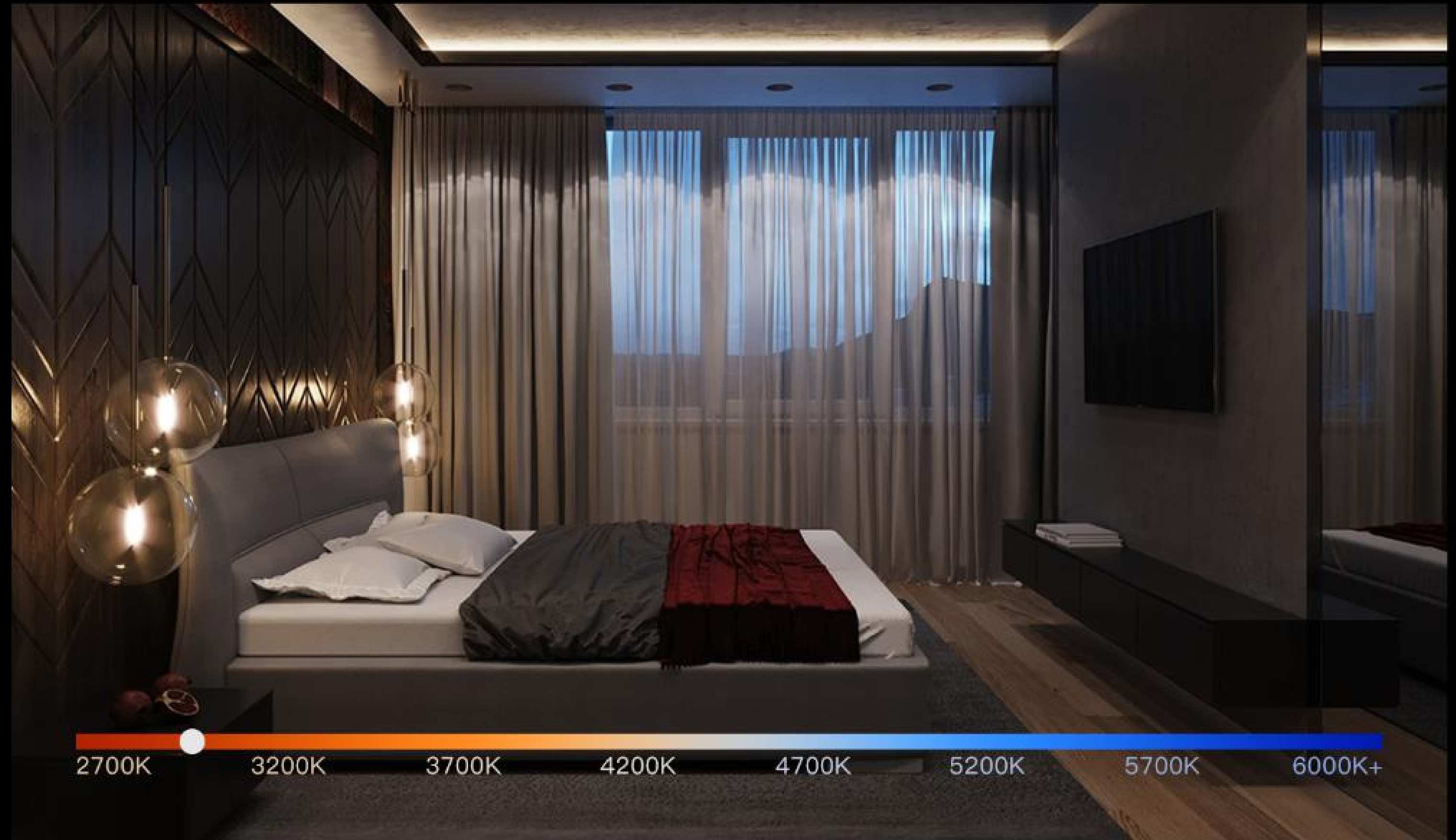

S series parameters

Zigbee Smart magnetic track light

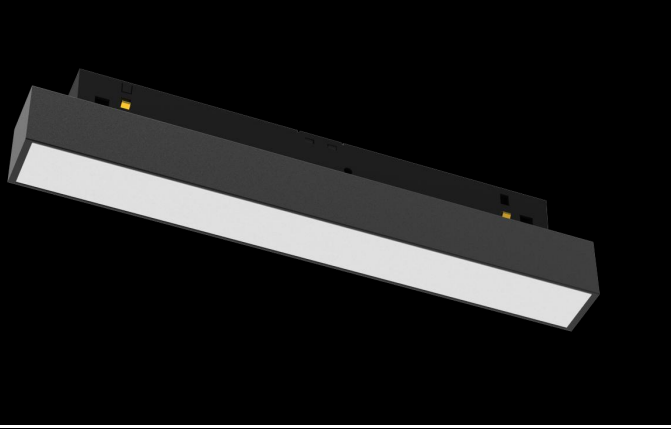
Picture						
Name	Smart magnetic track floodlight 8W	Smart magnetic track floodlight 15W	Smart magnetic track grille light 8W	Smart magnetic track grille light 15W	Smart magnetic track spotlight 8W	Smart magnetic track spotlight 15W
Size	207.5*22*25mm	410*22*25mm	207.5*22*25mm	410*22*25mm	Φ38*94mm	Φ60*110mm
Beam angle	110°±3°		70°±3°		24°±3°	
Input voltage	48V/50Hz					
Material	Aviation Aluminum; PC					
Color rendering index	CRI≥90Ra					
Color tem.	2700-6000k Stepless adjustment					
Protocol	Zigbee					
Control	Voice, touch screen, scene switch, APP					

Zigbee Anti-glare smart spotlight

Picture				
Name	Anti-glare smart spotlight 7W 24°	Anti-glare smart spotlight 7W 36°	Anti-glare smart spotlight 12W 24°	Anti-glare smart spotlight 12W 36°
Hole Size	φ55mm	φ55mm	φ75mm	φ75mm
Height	86mm	86mm	116mm	116mm
Beam angle	24°	36°	24°	36°
Input voltage	220-240V ~ 50/60Hz			
Material	Aviation Aluminum			
Color rendering index	CRI≥90Ra			
Color tem.	2700K-6000K			
Protocol	Zigbee			
Control	Voice, touch screen, scene switch, APP			

Zigbee S Series light strip

Picture	 <p data-bbox="1452 960 1952 1024">Light strip (S series)</p> <p data-bbox="2269 934 2925 1054">Smart light strip controller (S series)</p>
Rated power	120W
Input voltage	200-240V 50/60Hz
Color rendering index	CRI≥80Ra
Color tem.	2700K-6500K
Protocol	Zigbee
Control	Voice, touch screen, scene switch, APP

Function



Anti-glare smart spotlight

7W 24°/36°

- Product color rendering index $\geq 90Ra$, more real
- Suitable for local lighting, such as decorations or decorative paintings
- Small wattage, environmental protection and energy saving.
- LED chip, high efficiency and energy saving
- The anti-glare value is less than 13, no afterglow, no glare
- Integrated design, easy installation
- Suitable for home lighting with normal floor height



Anti-glare smart spotlight

12W 24°/36°

- Product color rendering index $\geq 90Ra$, more real
- Suitable for local lighting, such as decorations or decorative paintings
- Small wattage, environmental protection and energy saving.
- LED chip, high efficiency and energy saving
- The anti-glare value is less than 13, no afterglow, no glare
- Integrated design, easy installation
- Suitable for taller spaces with a height of 4-5 meters, such as villas, hotels, etc.

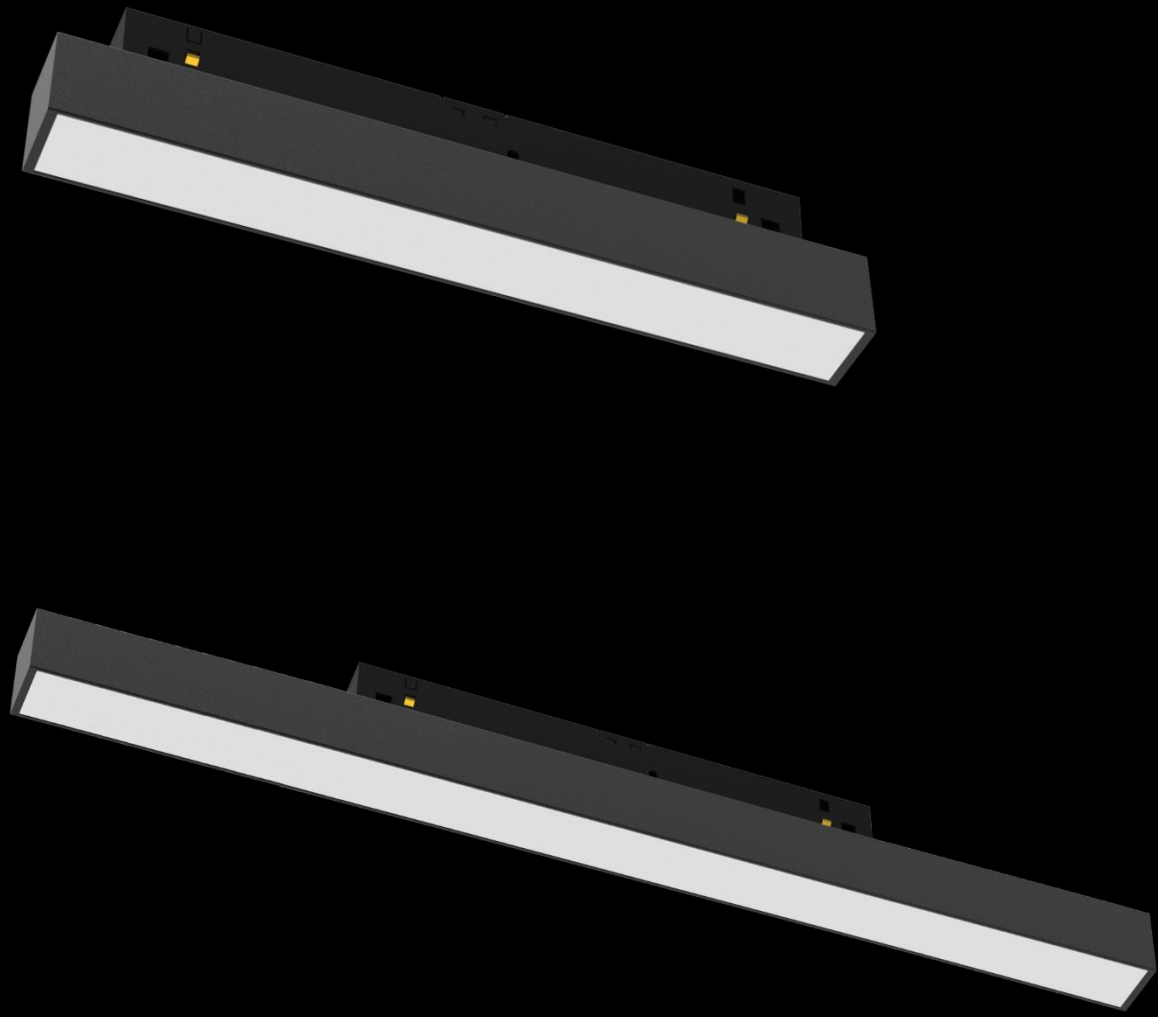

Smart magnetic track floodlight

8W/15W

- Product color rendering index $\geq 90Ra$, more real
- Basic lighting module, the main lighting function in the space,
- Magnetic installation, safe voltage, free sliding
- Mainly used for basic lighting for a wide range of light projections
- The anti-glare value is less than 19, not glare, creating natural light source

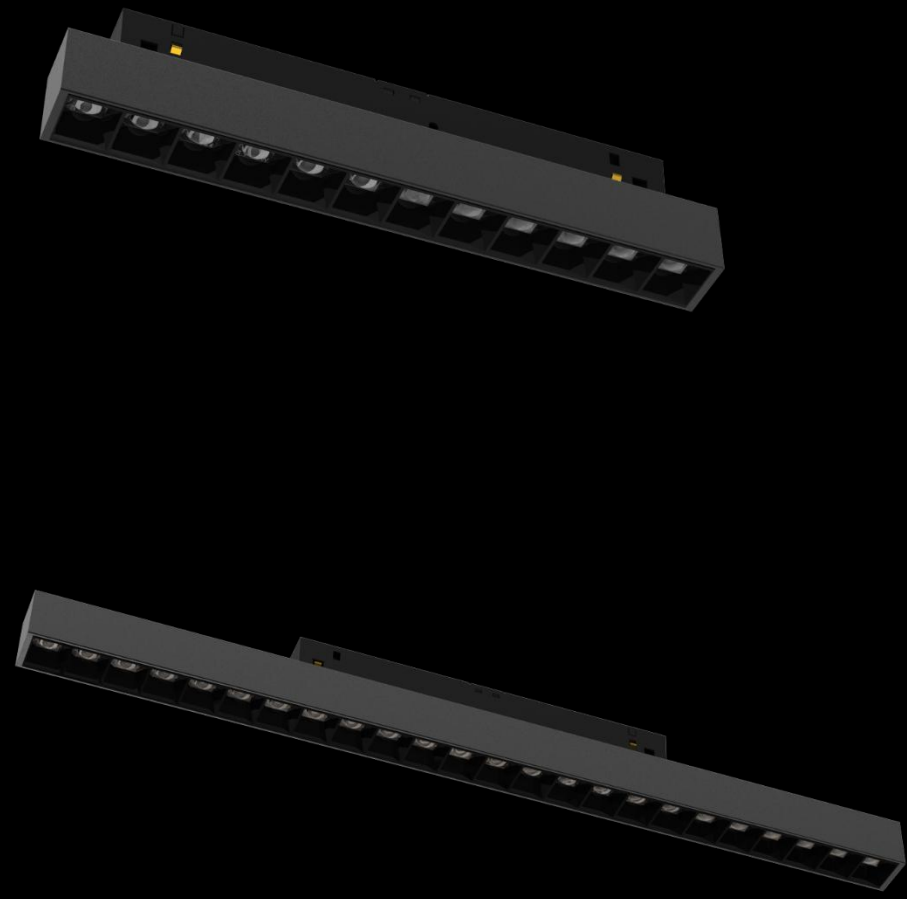

Smart magnetic track grille light

8W/15W

- Product color rendering index $\geq 90Ra$, more real
- Basic lighting module, main lighting function in the space
- Magnetic installation, safe voltage, free sliding
- The anti-glare value is less than 19, no afterglow, no glare, creating a natural light source
- The grille design is anti-glare and dust-proof, prolongs the service life of the lamp, and is not easy to be damaged or damaged.



Smart magnetic track spotlight

8W/15W

- Product color rendering index $\geq 90Ra$, more real
- Can slide freely, universally change the irradiation angle
- Magnetic installation, safe voltage
- The light source can refract the wall
- The anti-glare value is less than 19, no afterglow, no glare, creating a natural light source
- Suitable for accent lighting of bedside, wine cabinet, murals, handicrafts, etc.

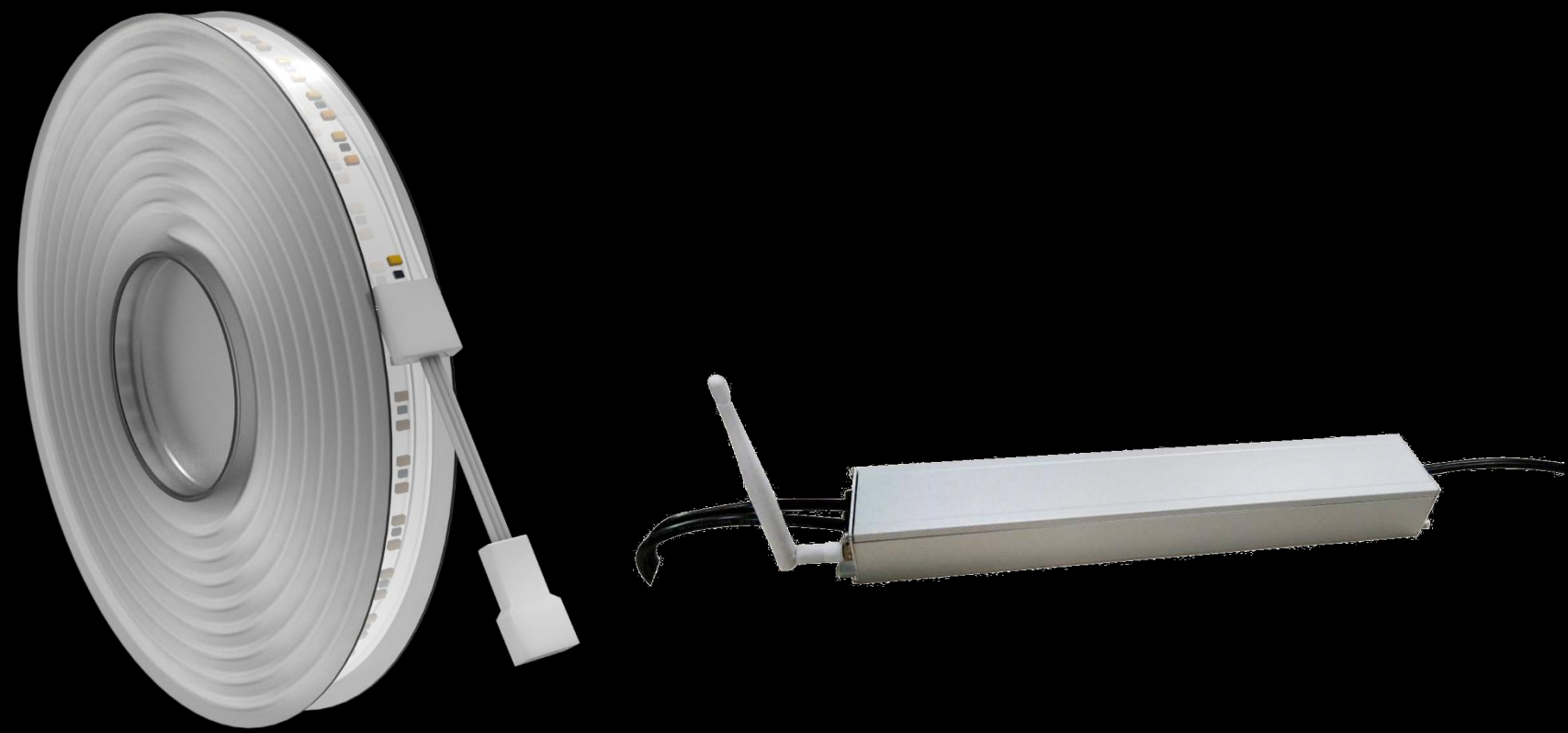

Zigbee Smart light strip kit S series
(controller+light trip)

- Integrated design, Plug and play
- Two-stage power supply, no flicker design
- Cold and warm light color dimming
- dustproof and moisture-proof
- High PF value, full load PF value reaches above 95
- 5 meters/roll

Design guide

Two layout methods of magnetic track



1. Installation on the top surface

2. Wall installation

Note:
Grille lights and track spotlights are preferred for wall installation, Floodlights are prone to glare.

Living room lighting layout

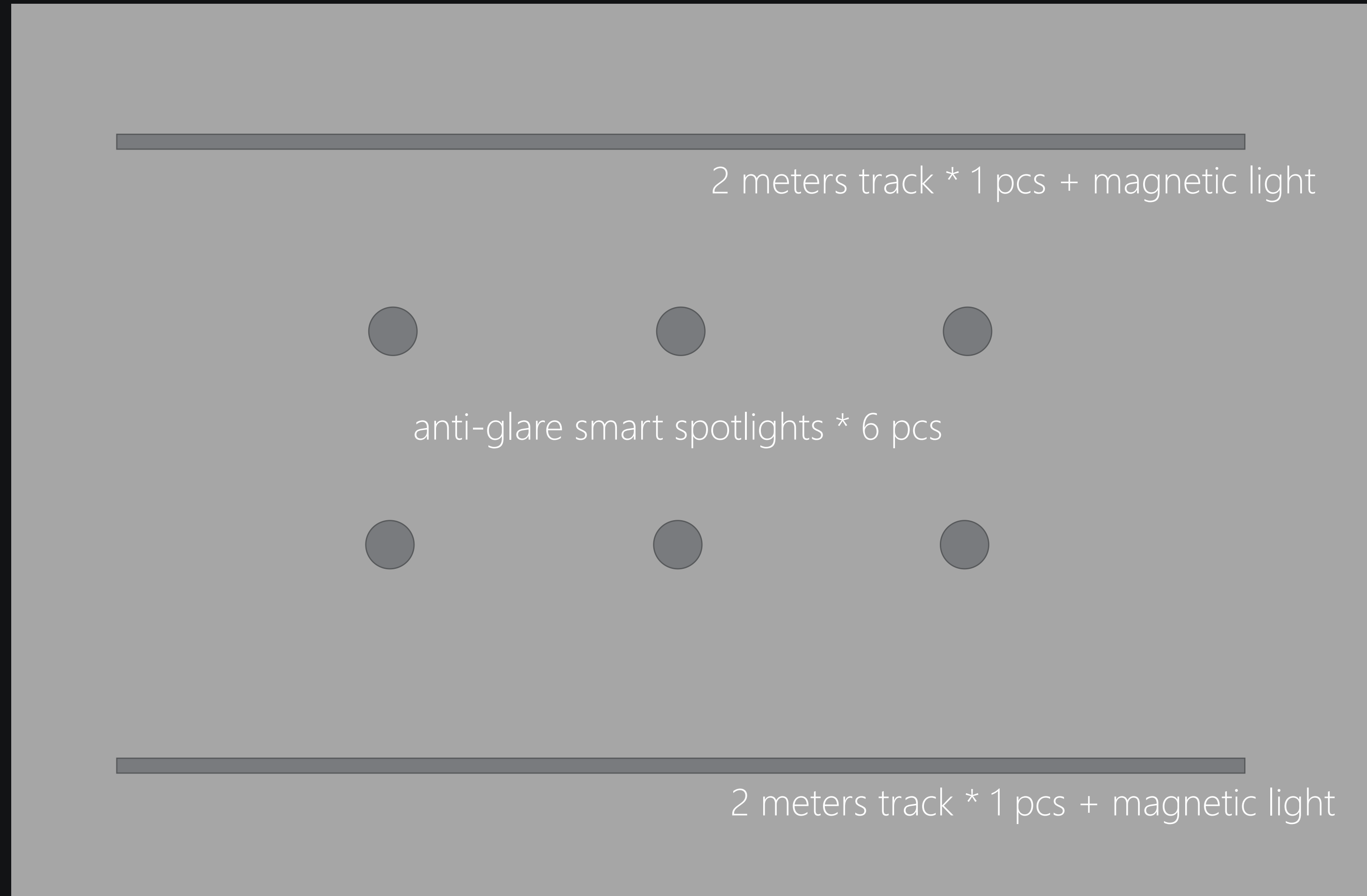

- Above the TV cabinet and sofa
- Layout 1 pcs 2m magnetic track respectively
- Plus 6 anti-glare smart spotlights

(Schematic on the floor plan)

Living room magnetic track light product combination

Product	Specification	Quantity
Magnetic track	2 meters/root	2
Smart magnetic track spotlight	8W	4
Smart magnetic track floodlight	15W	2
Smart magnetic track grille light	8W	2
Smart magnetic track grille light	15W	2
Magnetic track embedded power supply	100W	2

*Can add 6 anti-glare smart spotlights and S Series light strip kit

Living room lighting effect schematic



Restaurant lighting layout



- The magnetic track is hoisted above the dining table,
- The length of the table can be adjusted to the length of the track
- Plus 6 anti-glare smart spotlights

(Schematic on the floor plan)

Restaurant magnetic track light product combination

Product	Specification	Quantity
Magnetic track	2 meters/root	1
Smart magnetic track floodlight	8W	1
Smart magnetic track grille light	15W	2
Magnetic track embedded power supply	100W	1

*Can add 6 pcs anti-glare smart spotlights and S Series light strip kit

Restaurant lighting effect schematic



Bedroom lighting layout



- A magnetic rail is respectively hoisted on the aisle above the head of the bed and opposite the head of the bed
- Plus 2 anti-glare smart spotlights

(Schematic on the floor plan)

Bedroom magnetic track light product combination

Product	Specification	Quantity
Magnetic track	2 meters/root	2
Smart magnetic track spotlight	8W	4
Smart magnetic track floodlight	15W	2
Smart magnetic track grille light	8W	2
Smart magnetic track grille light	15W	2
Magnetic track embedded power supply	100W	2

*Can add 2 pcs anti-glare smart spotlights and S Series light strip kit

Bedroom lighting effect schematic



Corridor lighting layout

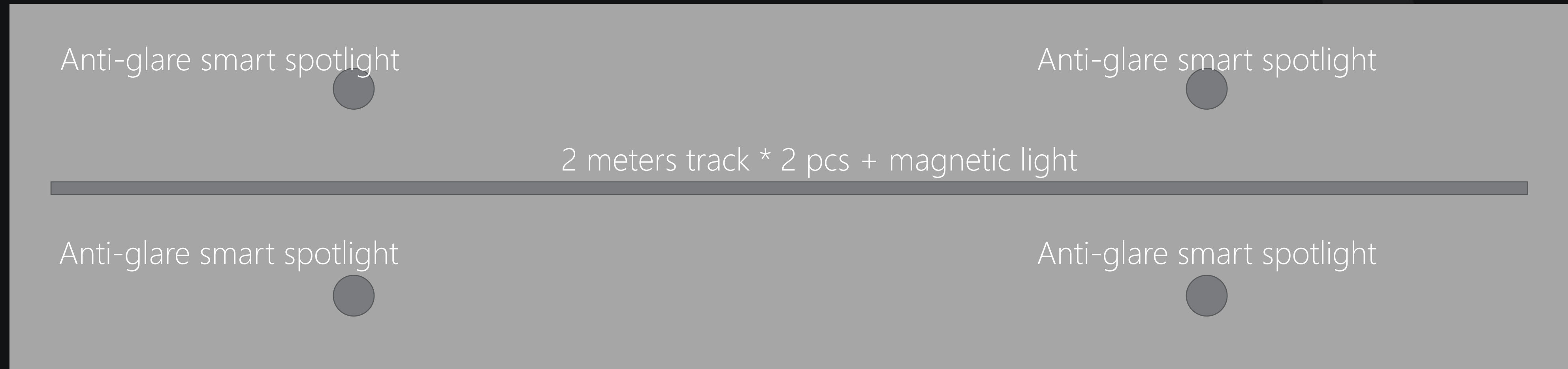

(Schematic on the floor plan)

- Layout magnetic track above the center line of the aisle
- The length can be adjusted according to the length of the aisle
- Plus 2 pcs anti-glare smart spotlights

Corridor magnetic track light product combination

Product	Specification	Quantity
Magnetic track	2 meters/root	2
Smart magnetic track spotlight	8W	2
Smart magnetic track floodlight	8W	2
Smart magnetic track grille light	8W	2
Smart magnetic track grille light	15W	2
Magnetic track connector		1
Magnetic track embedded power supply	100W	1

*可外加2个防眩智能射灯



Corridor lighting effect schematic

Retail display

Store Necessary

S series showcase

- Portability: Home improvement company/customer's home/store multi-scene display
- With screen: can directly demonstrate smart lighting scenes and express selling points
- Good texture: matte box, leather handle, metal buckle
- Can experience: can experience magnetic disassembly, MixPad direct interaction
- Full product range: Covers a full range of SKUs, with MixPad included in the package

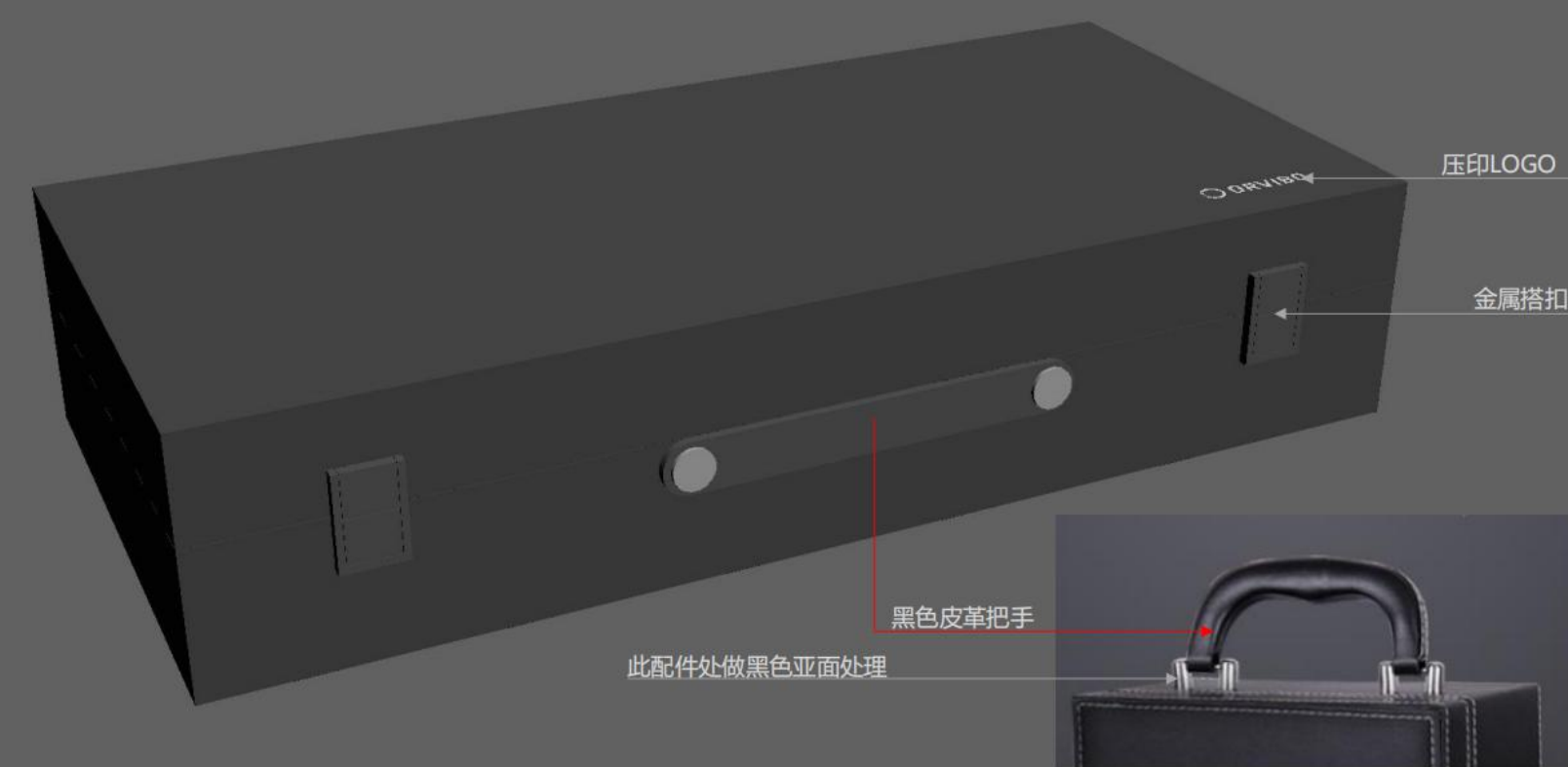
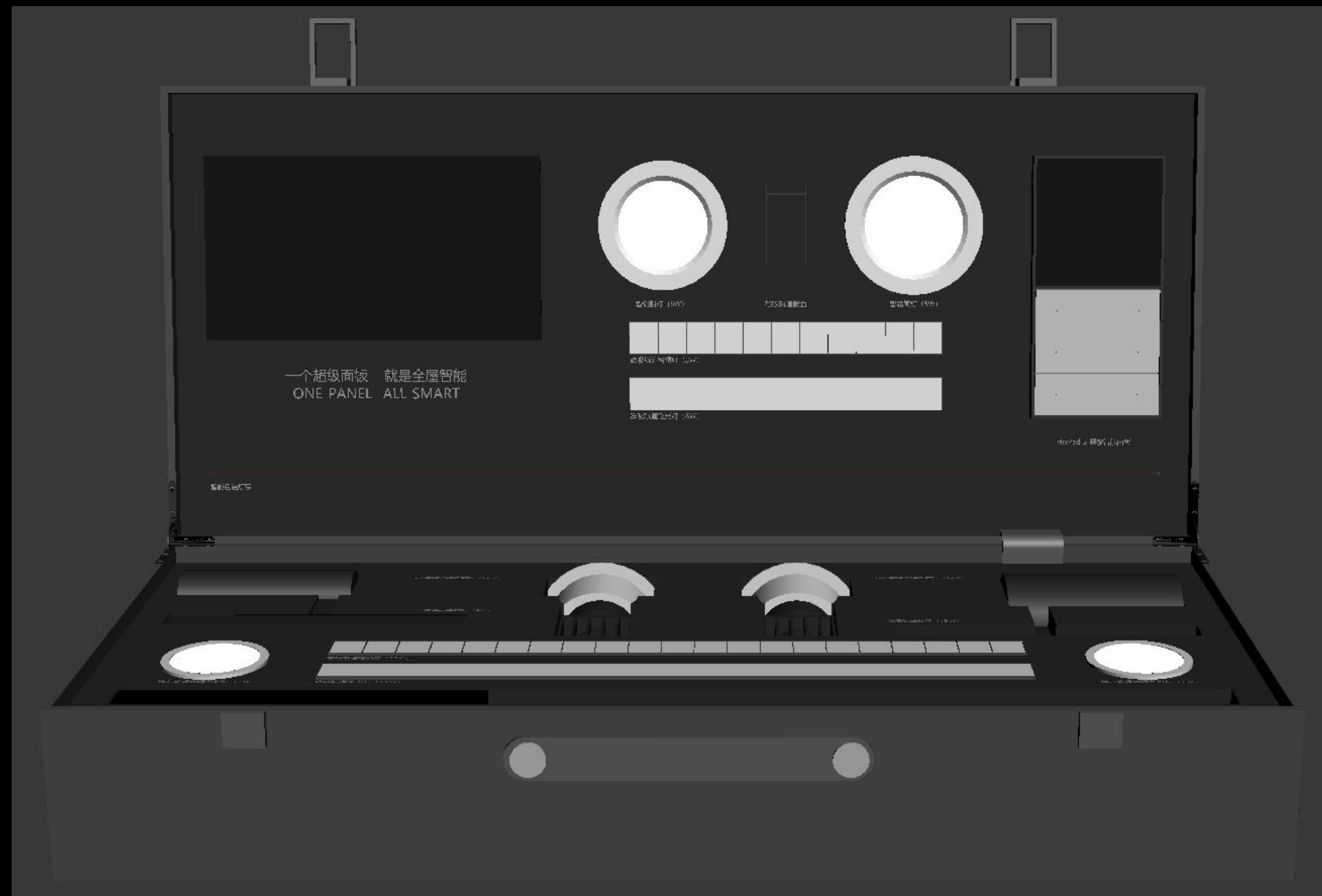

S series showcase - Product List



smart downlight 5w

smart spotlight 6w

10.4 inches screen

Mixpad S

Can connect to USB to play video

Smart magnetic track grille light
8W

Smart magnetic track floodlight
8W

S Series light strip

Smart magnetic track spotlight
8W

Smart magnetic track spotlight
15W

Anti-glare smart spotlight 12W
Can be removable, not bright

Anti-glare smart spotlight 12W
Removable, non-lighting

Anti-glare smart spotlight 7W
Can be bright, not removable

Anti-glare smart spotlight 7W
Can be bright, not removable

Magnetic track embedded
power supply

Smart magnetic track floodlight
15W

Smart magnetic track grille
light 15W

Magnetic track

S series showcase - Product List

No.	Name	Quantity
1	MixPad S	1
2	Smart magnetic track spotlight 8W	1
3	Smart magnetic track spotlight 15W	1
4	Smart magnetic track floodlight 15W	1
5	Smart magnetic track floodlight 8W	1
6	Smart magnetic track grille light 15W	1
7	Smart magnetic track grille light 8W	1
8	Magnetic track embedded power supply	1
9	Anti-glare smart spotlight 7W 24°	1
10	Anti-glare smart spotlight 7W 36°	1
11	Anti-glare smart spotlight 12W 24°	1
12	Anti-glare smart spotlight 12W 36°	1
13	Smart spotlight	1
14	Smart downlight	1
15	Magnetic track	1 pcs
16	S Series light strip kit	1 meter
17	Showcase box	1

Product comparison

Comparison

Name	Zigbee smart light (spotlight、downlight)	Anti-glare smart spotlight
Picture		
Material	Plastic coated aluminum	Aviation aluminum, better hardness and heat dissipation
Anti-glare	general	Anti-glare index < 13
Performance	Low power	Medium and high power, longer life
Size	φ75	φ55 & φ75
Application	Home	Home, villas, exhibition halls, high-end restaurants, etc.
Price	Low	High

