



ORVIBO

# ORVIBO AI Light



PART

TWO

2

Description

ORVIBO  
AI Lighting

Super smart lighting  series

SUPER  LIGHT

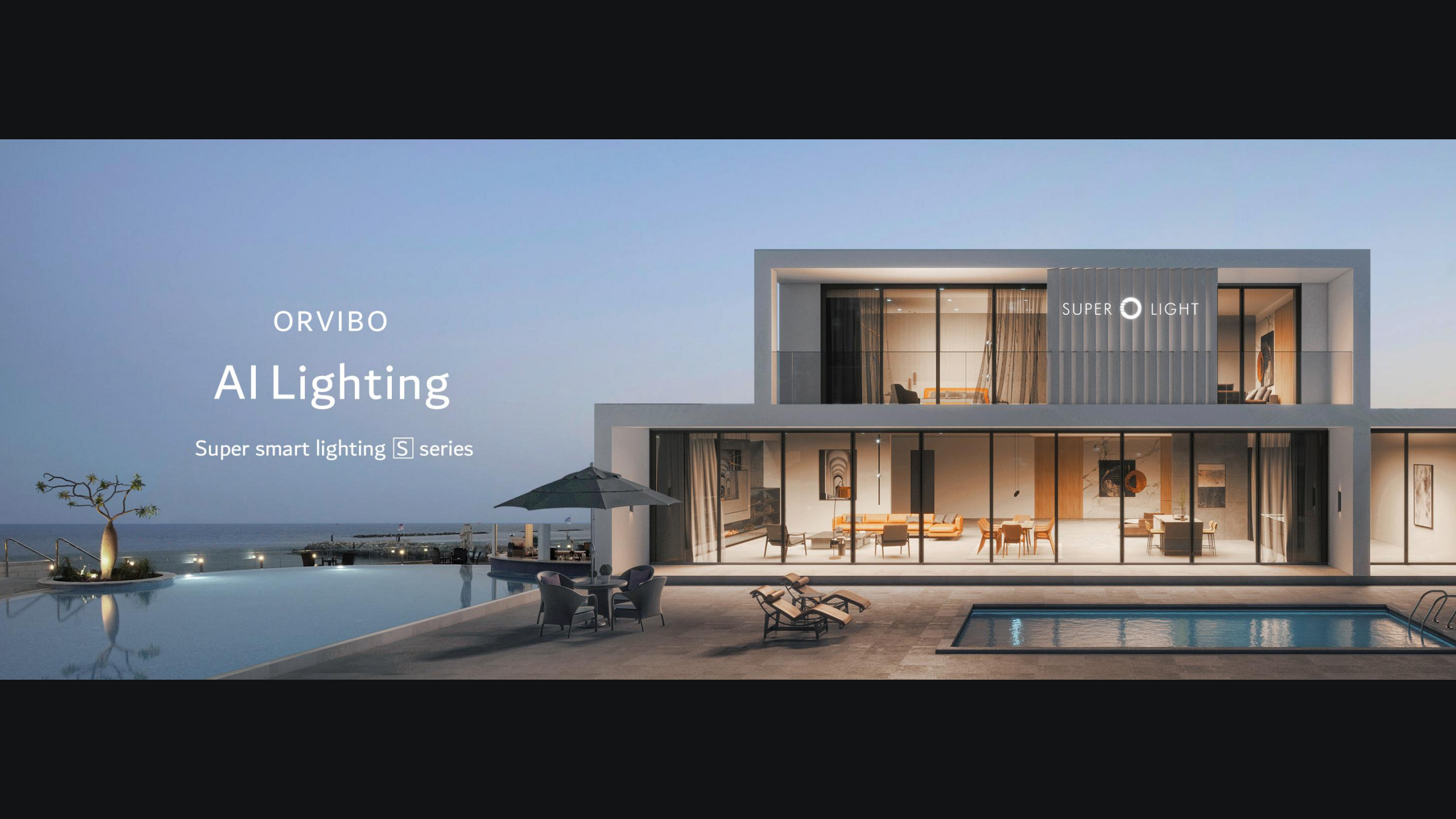

ORVIBO AI LIGHT

# More Intelligence For Better Life



MixPad AI smart control



PWM Dimming technology



No video flash, eye protection

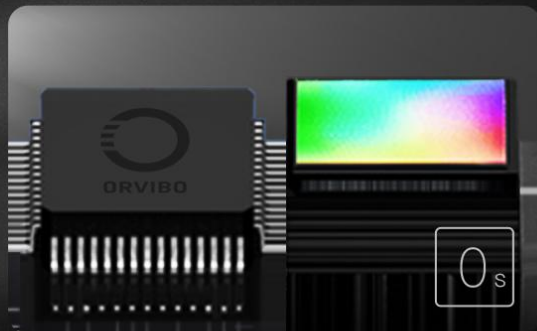

Self-developed centralized control

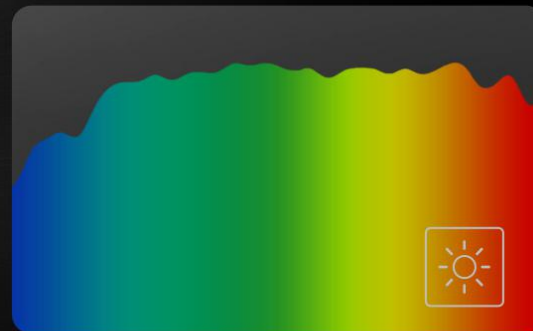

Low blue light damage

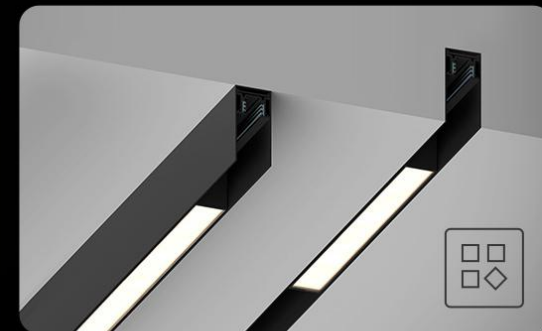

Complete range of smart lights

ORVIBO AILIGHT

# Budget at 5% Achieve 95% Results

 Click to turn on the lighting effects

The light and shade are just right

 Click to turn on the lighting effects

More lighting solutions

 Click to turn on the lighting effects

Space atmosphere creation

# AI Voice Control

Use with mixpad series to achieve voice control.

One Step 2.0

No wake-up control

too dark

OK



# One Key To Control The Full House Lighting

Link with ORVIBO smart home, curtains and music  
to create an integrated smart experience



# Automatic Adjustment Turn On The Lights For You

It can provide different light effects for different spaces and better match people's living habits and circadian rhythms.

\*This function is in the development stage and will be launched soon

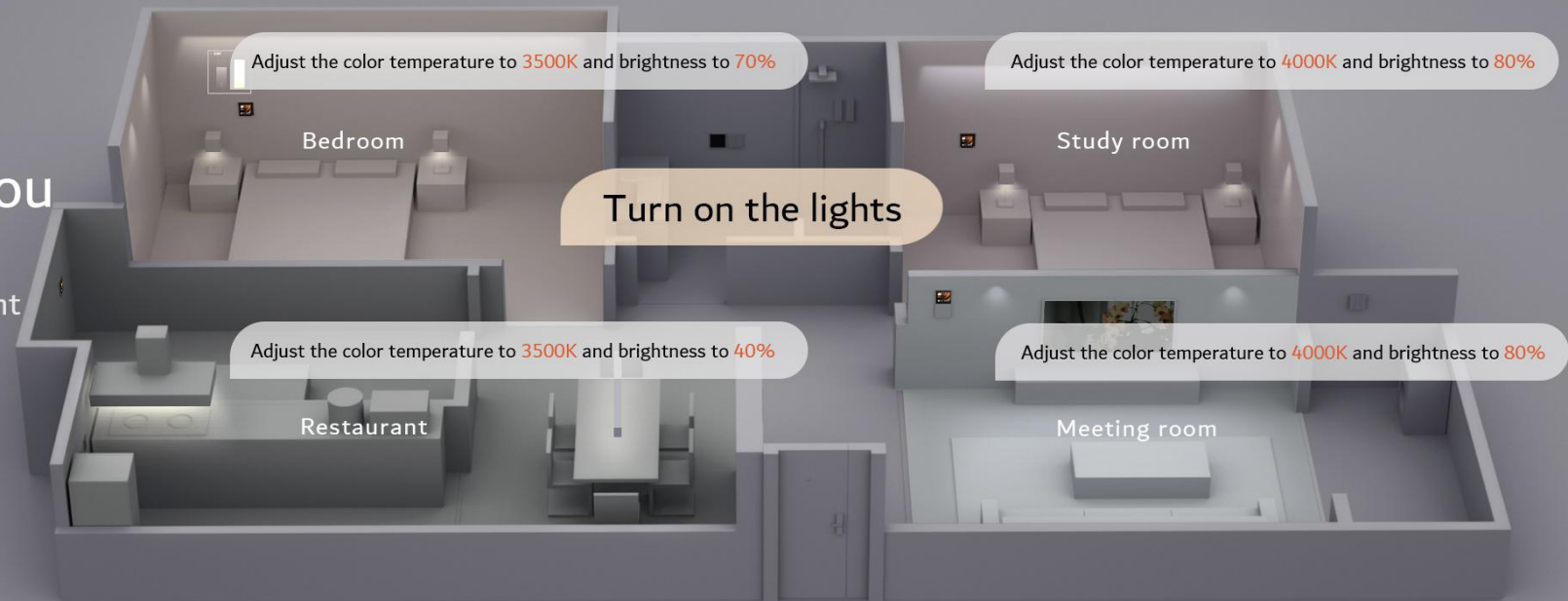



ORVIBO AI Light

**More Intelligent, More Change**

More Smart, More Changes

# Color temperature brightness adjustment Thousands of light colors for you to choose

Say goodbye to the "cold white light, warm white light, and warm yellow light" three-stage rigid adjustment, expand the brightness and color temperature range to ten thousand, presenting a rich atmosphere of light.



More Smart, More Changes



No wiring & Super fast response

## Self-Developed Centralized Control Technology Hundred Lights Group Control

Use self-developed communication technology to match professional networking modules for the full range of lamps. Even if the Wi-Fi at home is disconnected, the smart scenes stored locally can be implemented normally.



More Smart, More Changes

## Adopt Pwm Dimming Accurate And Stable Without Color Cast

Use the pulse waveform signal to adjust the brightness and color temperature of the light, without flickering or color cast due to unstable current.

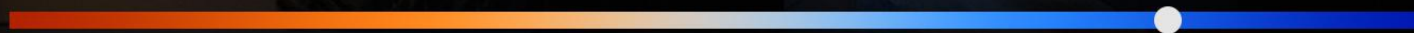

ORVIBO AI Light

**Museum-level Healthy Light**

Museum-level healthy light

## 3840Hz ultra high frequency light wave Eye protection without flicker

The greater the frequency of the light output waveform,  
the less the stroboscopic hazard. The output frequency of  
ORVIBO smart light is up to 3840Hz, no visible flicker,  
and excellent eye protection effect



Swipe down ▼

Museum-Level Healthy Light

## Simulate Solar Spectrum Naturally Low Blue Light

High-energy short-wave blue light is light with a relatively high energy wavelength between 400nm-450nm. After rigorous testing, AI Lighting products have low blue light peaks, close to sunlight, and light naturally effectively reduces vision damage.

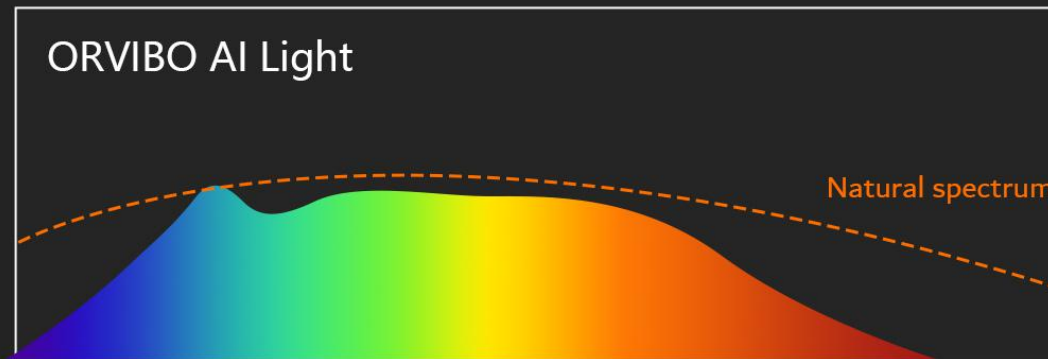
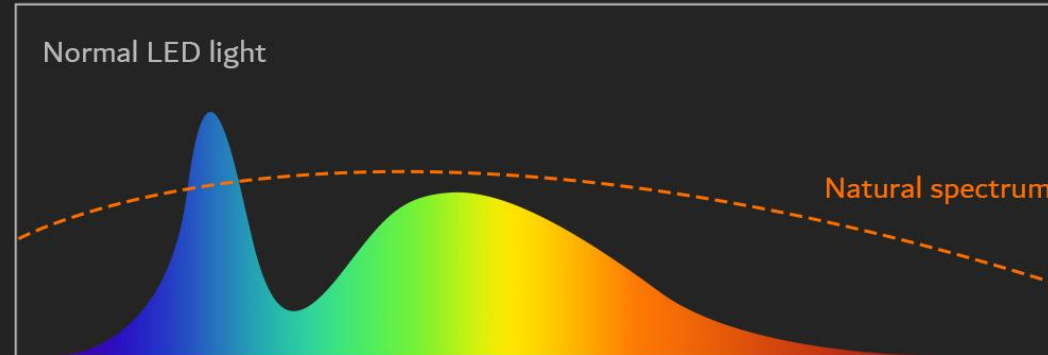

Closer to natural light, more comfortable and soft

Swipe down ▼

Museum-Level Healthy Light

# Strictly Tested Durable

Create truly good quality!

Bring home a longer and warm experience.



**100000 times**

Switch light test



**-20~60°C**

Temperature work test



**95%RH**

High humidity environment test



**10% NH<sub>4</sub>Cl**

Anti-corrosion test



**-40°C /48H**

Storage test



**1m drop**

Appearance/function inspection

Swipe down ▼



## Multi-space Application

Nearly 30 high-end smart light in the S series can be matched freely, breaking the various restrictions of home decoration style, floor height, and area, bringing the AI lamp experience.

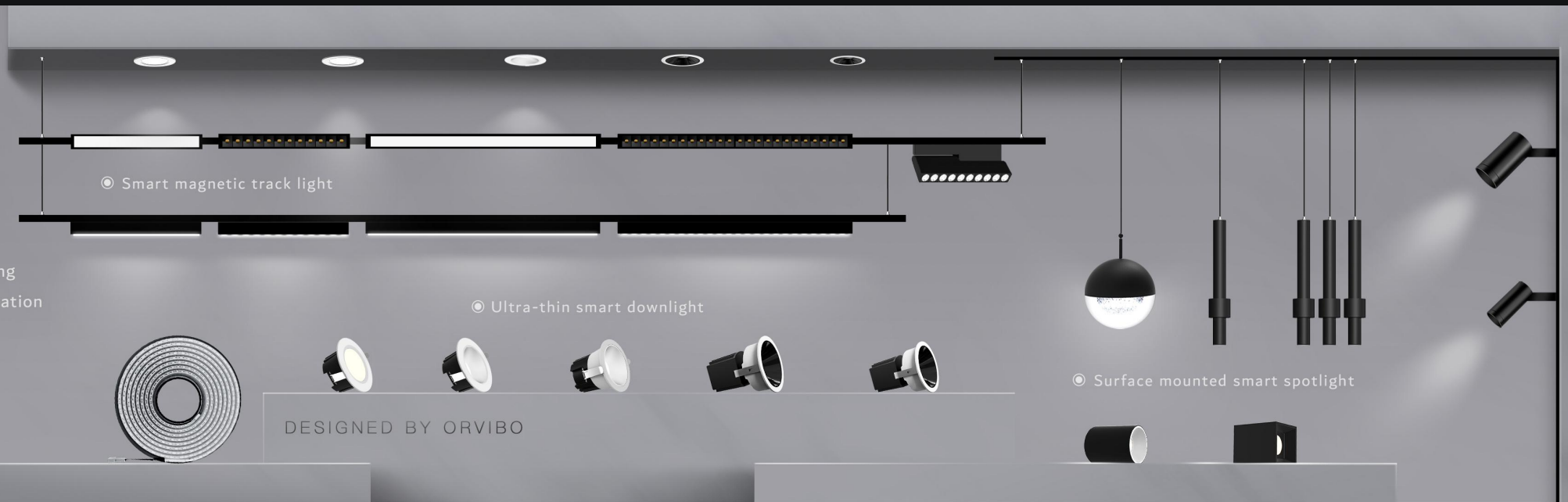

# AI LIGHT



## High-end villa



### Villa AI light

Anti-glare smart spotlights, smart magnetic track lights series smart lights can be used

## Apartment

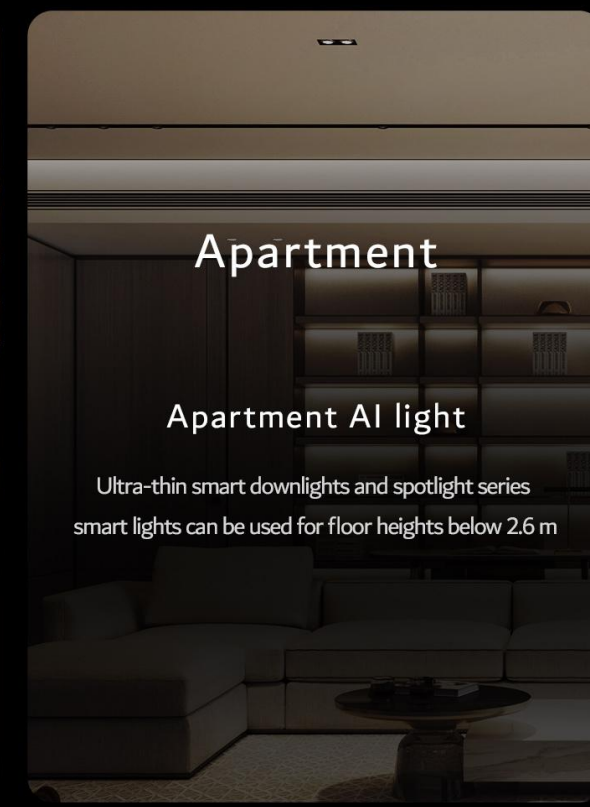

### Apartment AI light

Ultra-thin smart downlights and spotlight series smart lights can be used for floor heights below 2.6 m

## No ceiling design



### Surface mounted AI light

Surface-mounted smart spotlights and smart magnetic track lights can be used for no ceiling space

PART  
THREE



PRODUCT  
DETAILS



## Ultra-thin Smart Light

### Selling point

- Color rendering index>90
- Ultra-thin lamp body, use for 80mm ceiling
- 75~85mm large opening compatible
- 3840Hz high frequency dimming, no video flicker



### Parameter

Product name: ultra-thin smart spotlight  
7w24° S1

Product model: DT40Z07A

Product power: 7w

Wireless connection: industrial-grade Zigbee

Beam angle: 24°

Light flux: 455lm

Color temperature range: 2700K-6000K

Hole size: 75mm~85mm

Product size: Φ96mm X46mm

Product name: Ultra-thin smart downlight  
7w105° S1

Product model: DT40Z07B

Product power: 7w

Wireless connection: industrial-grade Zigbee

Beam angle: 105°

Luminous flux: 420lm

Color temperature range: 2700K-6000K

Hole size: 75mm~85mm

Product size: Φ96mm X46mm



## Anti-Glare Smart Spotlight

### Selling point

- Color rendering index up to 98Ra
- 10000 level silky dimming
- Black light technology UGR<13
- 3840Hz high frequency dimming, no video flicker



### Parameter

Product name: Anti-glare smart spotlight  
7w24° S1

Product model: DT50Z07A

Product power: 7w

Wireless connection: industrial-grade Zigbee  
Beam angle: 24°

Luminous flux: 470lm

Color temperature range: 2700K-6000K

Face ring color: gold, black, elegant white

Hole size: 75mm

Product size: Φ85mm X74mm



## Surface Mounted Smart Spotlight

### Selling point

- Color rendering index>90
- Can be installed without ceiling
- Built-in driver, more beautiful installation
- 3840Hz high frequency dimming, no video flicker



### Parameter

Product name: Surface mounted square  
smart spotlight S3

Product model: DT60Z07A

Product power: 7w

Wireless connection: Zigbee

Beam angle: 28°

Light flux: 385lm

Color temperature range: 2700~6000K

Product color: black, white

Product size: 75mm x 75mm x 95mm

Product name: Surface mounted circular  
smart spotlight S3

Product model: DT40Z07B

Product power: 7w

Wireless connection: Zigbee

Beam angle: 28°

Light flux: 385lm

Color temperature range: 2700~6000K

Product color: black, white

Product size: Φ93mm X106mm



## Smart Magnetic Fold Grille Light

### Selling point

- Color rendering index Ra>93
- 48v safe voltage
- Support single light single control
- Support dimming and color matching



### Parameter

Product Name: Smart Magnetic Fold  
Grille light 12W S2

Product model: DG10Z12B

Product power: 12w

Wireless connection: industrial-grade Zigbee

Beam angle: 24°

Luminous flux: 600lm

Input voltage: DC48V

Color temperature range: 2700K-6000K

Product Size:

222mm X 22.5mm X 110mm



## Round Smart Magnetic Pendant Light

### Selling point

- Color rendering index Ra>93
- 48v safe voltage
- Support single light single control
- Support dimming and color matching



### Parameter

Product Name: Round Smart Magnetic  
Pendant Light S2

Product model: DD10Z06B

Product power: 6w

Wireless connection: industrial-grade Zigbee

Beam angle: 140°

Luminous flux: 480lm

Input voltage: DC48V

Color temperature range: 2700K-6000K

Size: luminous surface diameter 100mm





## Cylindrical Smart Magnetic Pendant Light

### Selling point

- Color rendering index Ra>93
- 48v safe voltage
- Support single light single control
- Support dimming and color matching



### Parameter

Product name: cylindrical smart magnetic  
Pendant light S2  
Product model: DD10Z05A  
Product power: 5w  
Wireless connection: Zigbee  
Beam angle: 14°  
Luminous flux: 25lm  
Input voltage: DC48V  
Color temperature range: 2700K-6000K  
Product size: connector length 222mm  
Height: 1200mm (adjustable)

Product name: cylindrical smart magnetic  
Pendant light S2 (three heads)  
Product model: DD10Z15A  
Product power: 3\*5w  
Wireless connection: Zigbee  
Beam angle: 14°  
Luminous flux: 3\*25lm  
Input voltage: DC48V  
Color temperature range: 2700K-6000K  
Product size: connector length 222mm  
Height: 1200mm (adjustable)



## Smart Magnetic Spotlight

### Selling point

- Color rendering index Ra>93
- 48v safe voltage
- Support single light single control
- Support dimming and color matching



### Parameter

Product name: smart magnetic spotlight 8W	Product name: smart magnetic spotlight 15W
Product model: DG10SA	Product model: DG10SB
Product power: 8w	Product power: 15w
Wireless connection: industrial-grade Zigbee	Wireless connection: industrial-grade Zigbee
Beam angle: 24°	Beam angle: 24°
Luminous flux: 350lm	Luminous flux: 850lm
Input voltage: DC48V	Input voltage: DC48V
Color temperature range: 2700K-6000K	Color temperature range: 2700K-6000K
Product size: Φ38*146mm	Product size: Φ60*156mm



## Smart Magnetic Floodlight

### Selling point

- Color rendering index Ra>93
- 48v safe voltage
- Support single light single control
- Support dimming and color matching

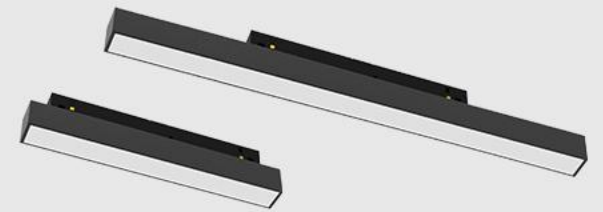

### Parameter

Product name: smart magnetic floodlight 8W	Product name: smart magnetic floodlight 15W
Product model: DG10GA	Product model: DG10GB
Product power: 8w	Product power: 15w
Wireless connection: industrial-grade Zigbee	Wireless connection: industrial-grade Zigbee
Beam angle: 110°	Beam angle: 110°
Luminous flux: 368lm	Luminous flux: 810lm
Input voltage: DC48V	Input voltage: DC48V
Color temperature range: 2700K-6000K	Color temperature range: 2700K-6000K
Product size: 207.5*22*25mm	Product size: 410*22*25mm



## Smart Magnetic Grille Light

### Selling point

- Color rendering index Ra>93
- 48v safe voltage
- Support single light single control
- Support dimming and color matching



### Parameter

Product name: Smart magnetic grille light 8W	Product name: smart magnetic grille light 15W
Product model: DG10FA	Product model: DG10FB
Product power: 8w	Product power: 15w
Wireless connection: industrial-grade Zigbee	Wireless connection: industrial-grade Zigbee
Beam angle: 70°	Beam angle: 70°
Luminous flux: 580lm	Luminous flux: 1120lm
Input voltage: DC48V	Input voltage: DC48V
Color temperature range: 2700K-6000K	Color temperature range: 2700K-6000K
Product size: 207.5*22*25mm	Product size: 410*22*25mm



## Smart Color Temperature Light Strip

### Selling point

- IP66 waterproof
- 0.1m minimum cutting distance
- 120 beads/s high density lamp beads
- 2700K~6500K color temperature adjustment

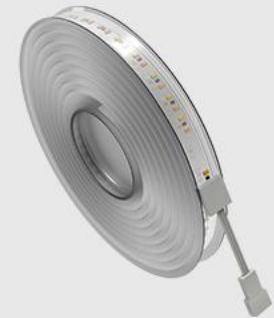

### Parameter

Product name: Smart color temperature

Light strip (S series)

Product model: LS20N

Product power: 30w/5m

Color rendering index: Ra>80

Light flux: 2800lm/5m

Color temperature range: 2700K~6500K

Input voltage: DC 24V

Product size: 14mm with rubber sleeve

Bare lamp with 10mm

# Magnetic track B accessories·Magnetic track outer corner B

Hole size: 30mm

Product size: 120\*120\*32.6mm

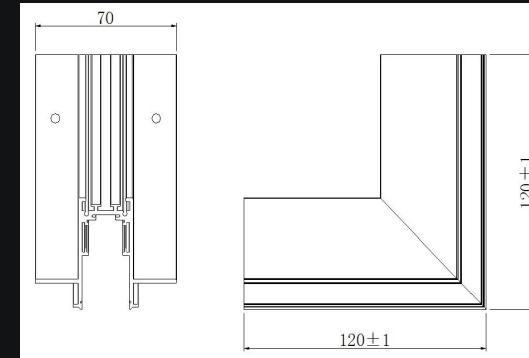
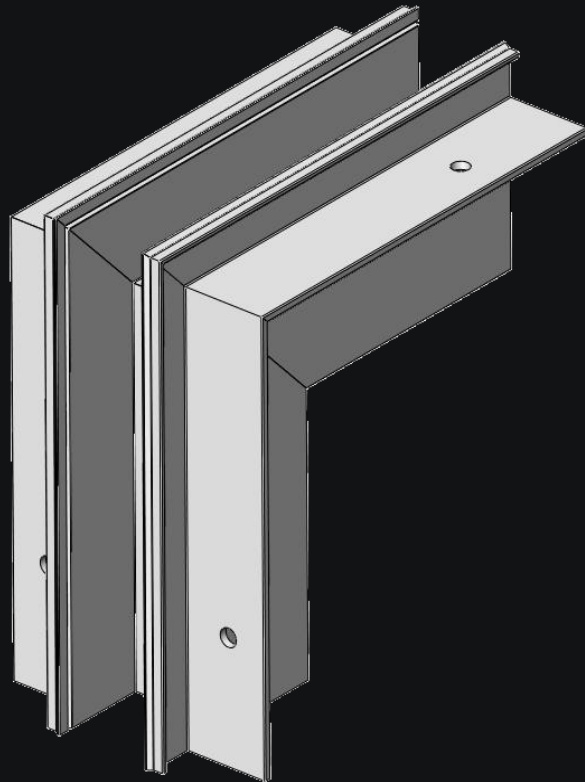

## Instructions

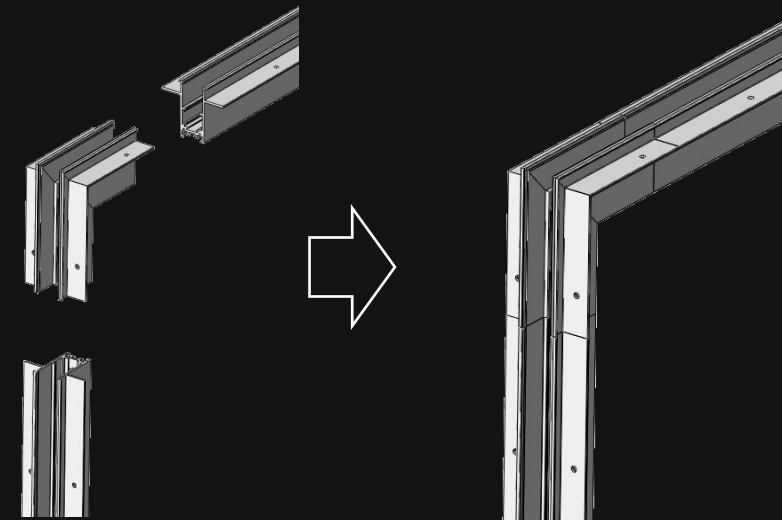

Note: The package comes with a screw accessory package.

# Magnetic track B accessories·Magnetic track flat angle B

Hole size: 30mm

Product size: 120\*120\*52.3mm

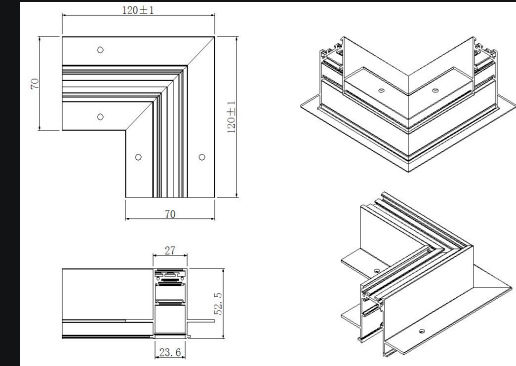
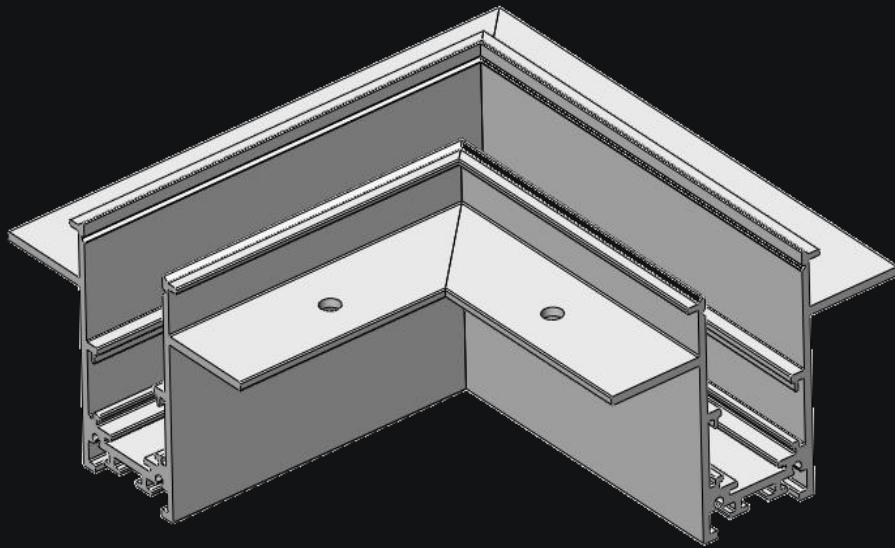

## Instructions

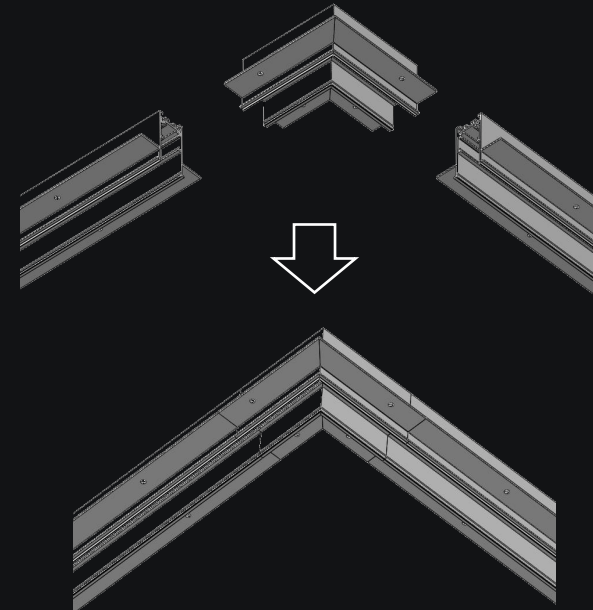

Note: The package comes with a screw accessory package.

# Magnetic track B accessories · Magnetic track inner corner B

Hole size: 30mm

Product size: 120\*120\*52.5mm

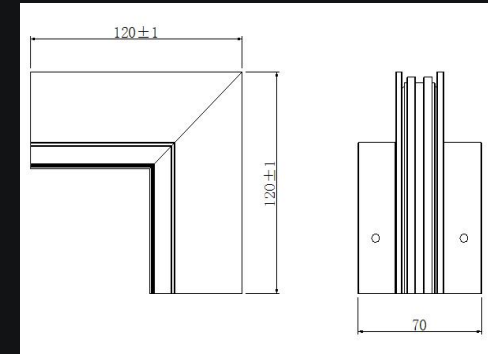
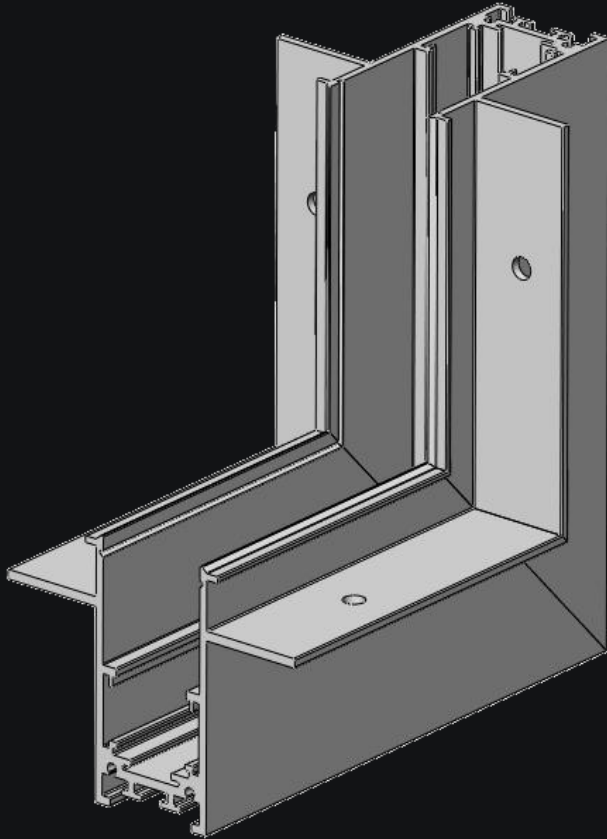

## Instructions

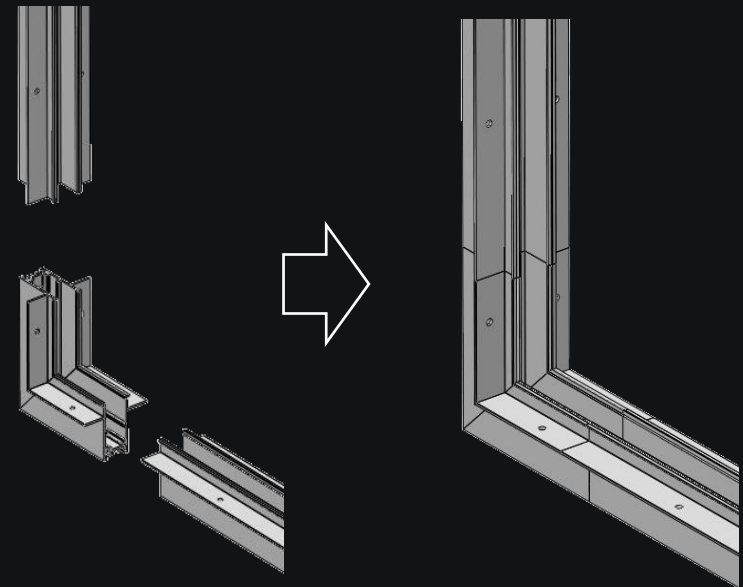

Note: The package comes with a screw accessory package.



PART

THREE

3

Design

# AI light series-plan 1

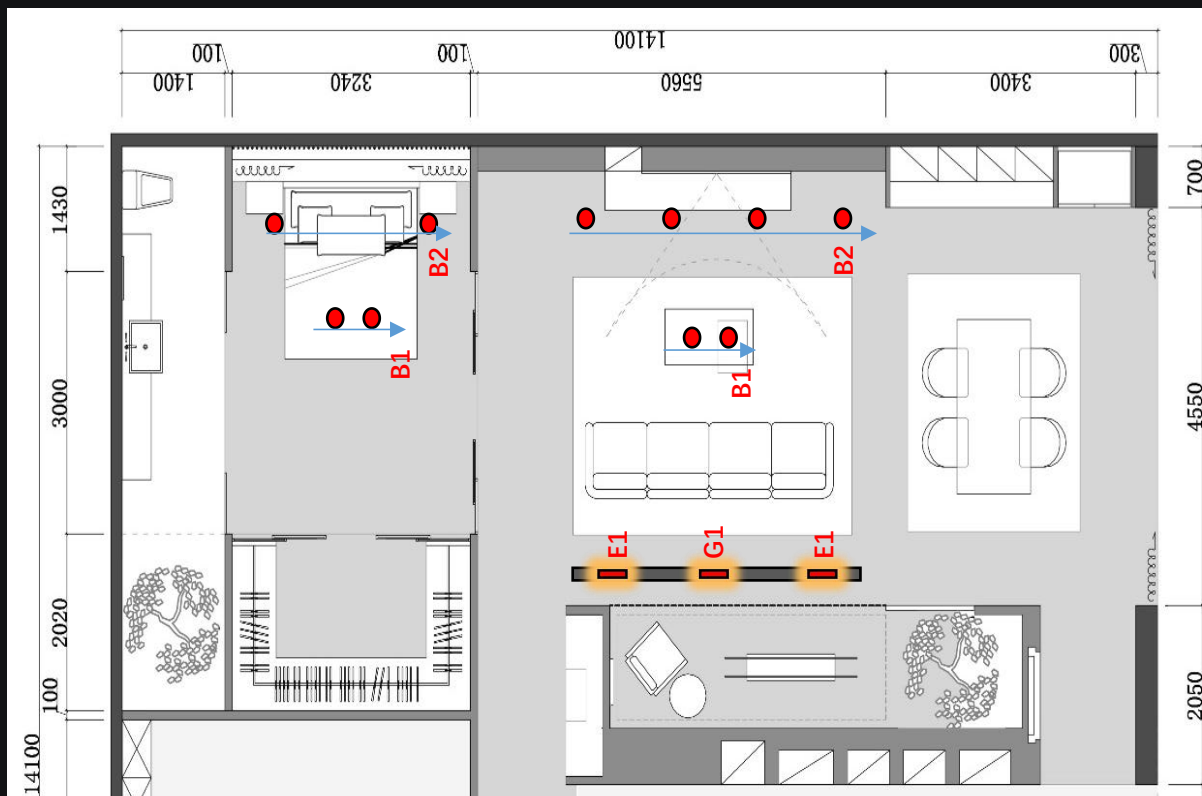

Mark	Type	Installation
B1	smart spotlight S3 (black)	Surface mounted
B2	smart spotlight S3 (black)	Surface mounted
E1	Smart magnetic grille light 15w	Magnetic
E2	Smart magnetic grille light 15w	Magnetic
F1	Surface mounted track (A)	Surface mounted
G1	Smart magnetic folding grille light 12W S2	Magnetic



morning



night



watch TV

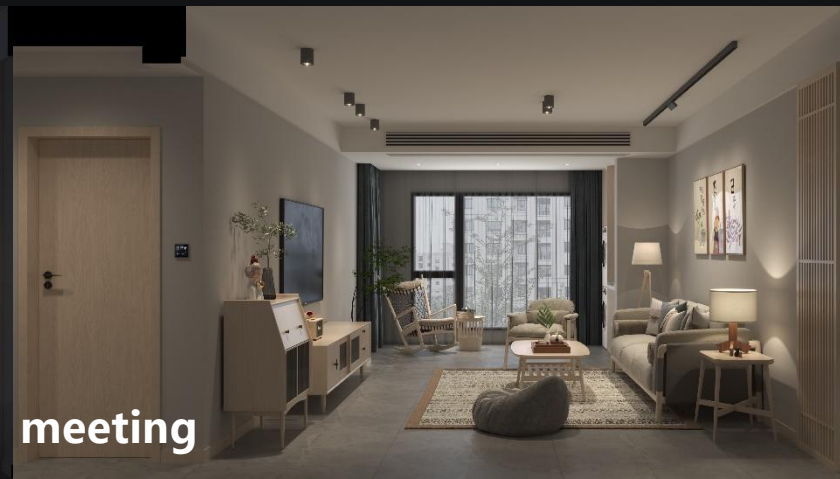

meeting



daily

# AI light-plan 2

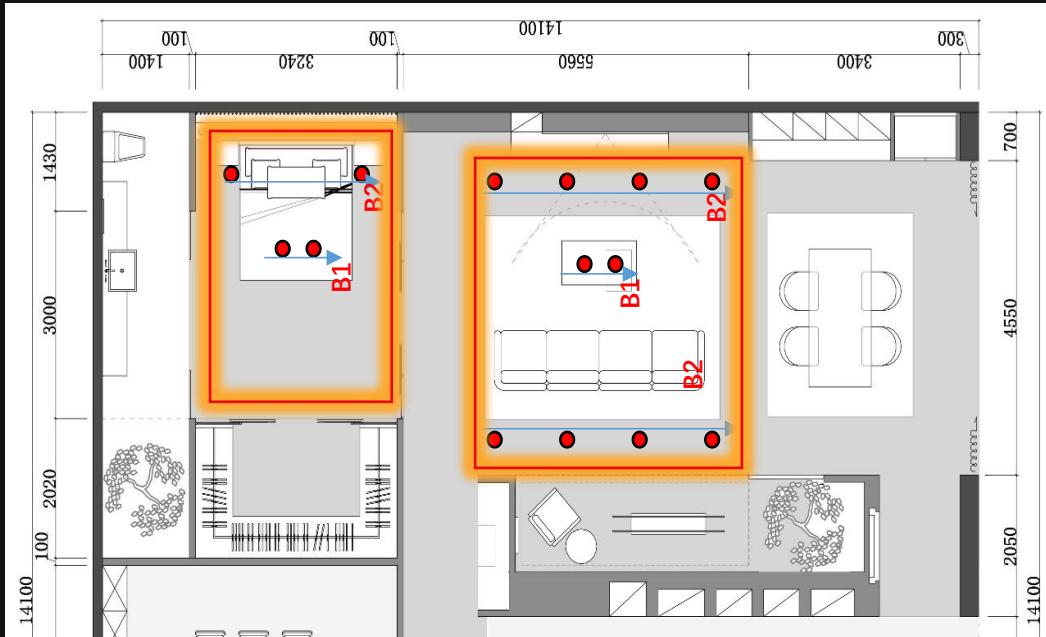

Mark	Type	Installation
B1	Anti-glare smart spotlight 7W 24° S1/ Ultra-thin anti-glare smart spotlight 7W 24° S1	Embed
B2	Anti-glare smart spotlight 7W 24° S1/ Ultra-thin anti-glare smart spotlight 7W 24° S1	Embed
I1	Smart light strip	Ceiling



sleeping

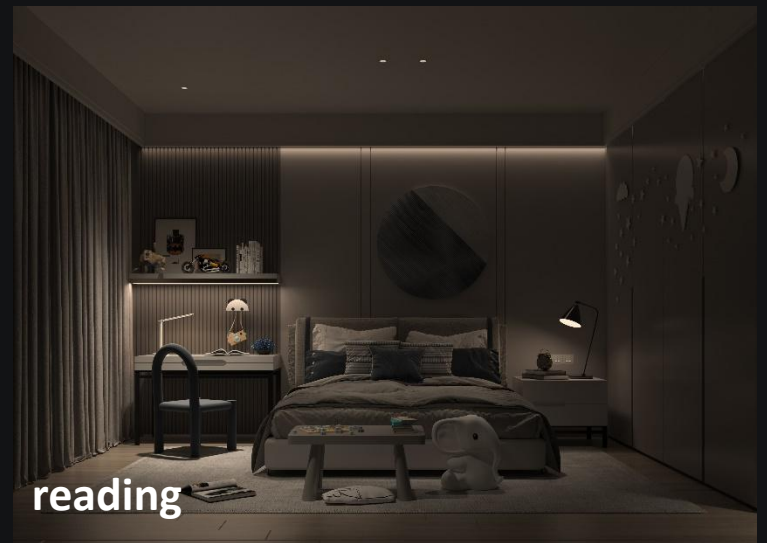

reading



painting

# AI light-plan 3

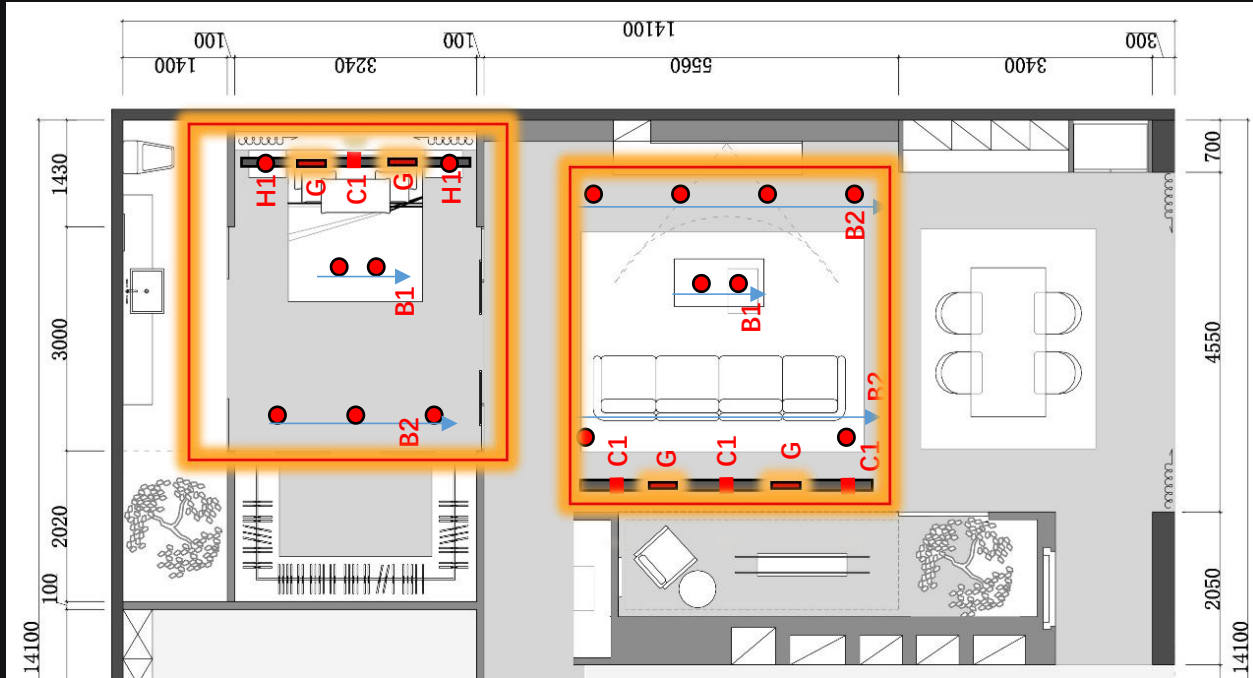

Mark	Type	Installation
B1	Anti-glare smart spotlight Pro 7w 24°	Embed
B2	Anti-glare smart spotlight Pro 7w 36°	Embed
C1	Smart magnetic spotlight 15W	Embed
F2	Embedded track (B)	Embed
G	Smart magnetic folding grille light 12W S2	Magnetic
H1	Smart Magnetic Suspension Light S2	Magnetic
I1	Smart light strip	Ceiling



# AI Light

The first generation of anti-glare smart spotlight series

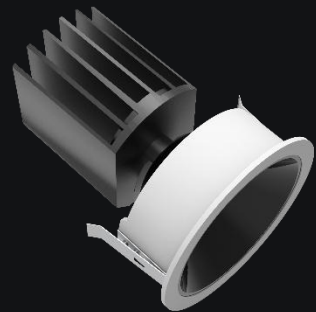

**Formally  
delisted**



# AI Light•Smart downlight & spotlight

Anti-glare Smart  
Spotlight Pro Series



Anti-glare smart  
spotlight S1 series

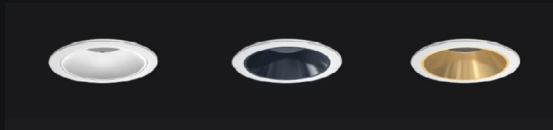

Ultra-thin smart  
spotlight/downlight S1 series



Smart  
spotlight/downlight



# AI Light•0-10V Anti-glare spotlight

0-10V anti-glare spotlight



0-10V anti-glare downlight



0-10V smart dimming module



# AI Light•Magnetic track light

Smart magnetic floodlight

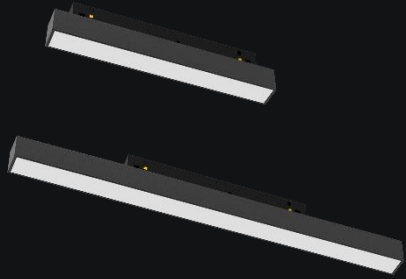

Smart magnetic grille light

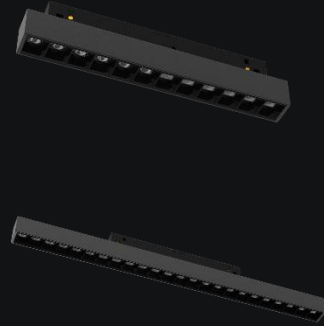

Intelligent magnetic spotlight



Smart magnetic folding grille light



Vertical Smart Magnetic Suspension Light S2



Vertical Smart Magnetic Suspension Light S2 (three type)



Round Smart Magnetic Suspension Light S2

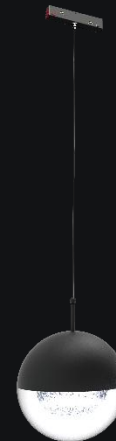

# AI Light•Magnetic track light accessories

Magnetic track connector  
(suitable for splicing two tracks)

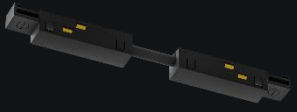

Smart magnetic embedded power supply (track power supply)



Magnetic track L-shaped connector  
(suitable for corner connectors)



Magnetic track A (suitable for surface mounting)



Inner corner

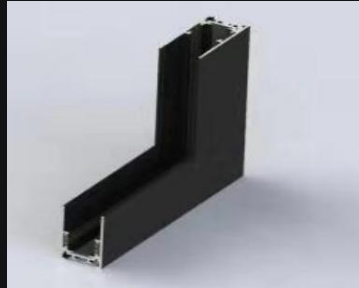

Outer corner

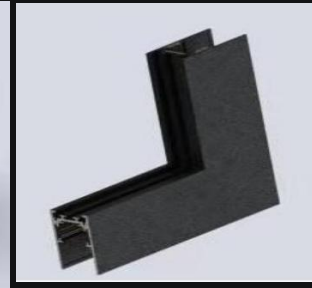

Flat corner



Hanging wire A



Magnetic track B (suitable for embedded)



Inner corner B

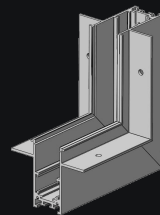

Outer corner B

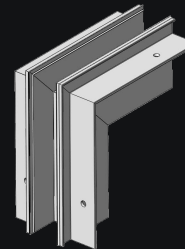

Flat corner B

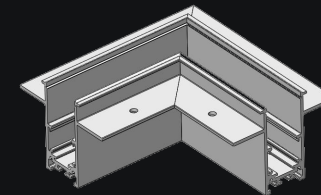

# AI Light•Surface mounted smart spotlight

Surface mounted round smart spotlight S3  
(black/white)



Surface mounted smart square spotlight S3  
(black/white)

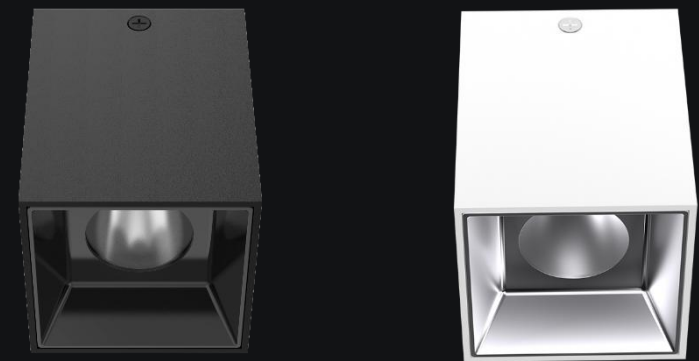

# AI Light•High-performance color temperature light strip

High-performance smart light strip controller



High-performance smart light strip



